

CONOMETER 80

VIEWING ANGLE IMAGING PHOTOMETERS



Fast viewing angle measurements of displays

Measures More — and Faster

The CONOMETER® 80 measures display viewing angles over a wide range of luminance — from black levels to the brightest backlights. Measurements of 100 cd/m² or more can be completed in less than one second, and low light level measurements down to 0.013 cd/m² can be completed in just ten seconds. The CONOMETER 80 is truly in a class by itself.

Simplicity

While measuring viewing angle performance with heavy, Fourier lens systems requires 6-axes stages or robots to achieve sample alignment, the CONOMETER 80 alignment procedure is straightforward and assured. Weighing only 0.5 kg, the CONOMETER 80 readily integrates into any test scenario. When placed directly at the display surface, the lens hood sets the optical axis for measurement, and shields the test from external stray light. Tip and tilt adjustments are not required — rotation and translation remain for complete alignment.

Analysis

Using the included [Photometrica software](#), users can quickly apply tools such as profiles to evaluate display performance. In addition, various measurement layers at different display settings are acquired in the same document to enable more complex display evaluations such as contrast, gamma, and inversion.



Key Features

- $\pm 80^\circ$ (160° total)
- 0.1°/px resolution
- 0.013 to 200 000 cd/m²
- Easy alignment
- Compact and portable

Applications

- Flat Panel Displays (FPD)
- Backlight Units (BLU)

CONOMETER 80

Areas of Interest

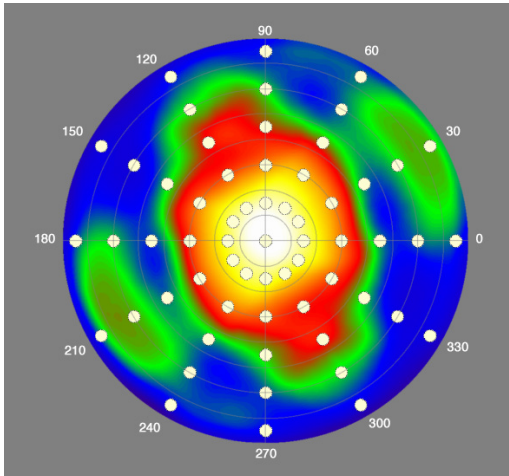

AOI	Y White cd/m ²	Y Red cd/m ²	Y Green cd/m ²	Y Blue cd/m ²	Y Black cd/m ²
(15,0)	258.4	61.74	174	27.35	0.2666
(30,0)	124.5	31.75	83.71	13.32	0.3774
(45,0)	41.21	11.7	26.94	4.634	0.4237
(60,0)	38.06	11.52	24	4.792	0.6524
(75,0)	36.21	11.81	22.69	5.145	0.7736
(15,30)	266.9	64.19	177.7	27.67	0.2479
(30,30)	135.1	34.49	90.91	14.82	0.6089
(45,30)	42.15	12.37	27.48	5.228	0.9247
(60,30)	49.02	17.42	32.15	8.327	2.858
(75,30)	57.25	25.44	38.07	13.96	6.389
(15,60)	282	66.86	188	29.56	0.2669
(30,60)	163.1	41.4	108.1	17.61	0.9308
(45,60)	64.97	19.69	42.4	8.151	1.657
(60,60)	39.08	14.29	25.46	6.648	2.6
(75,60)	39.8	17.14	27.57	9.672	4.739

User defined angles (AOIs) are plotted in the polar measurement and their statistics are reported in the table

Surface Plot

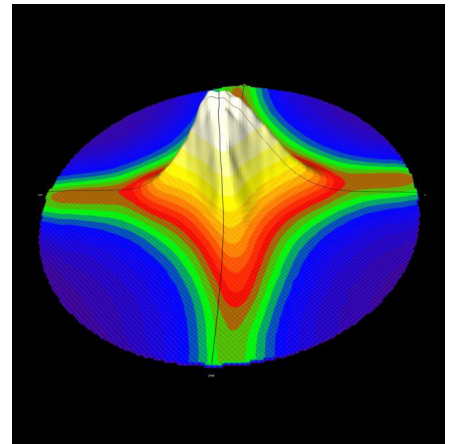
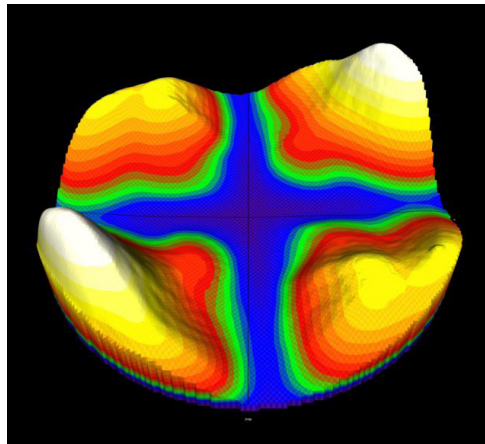
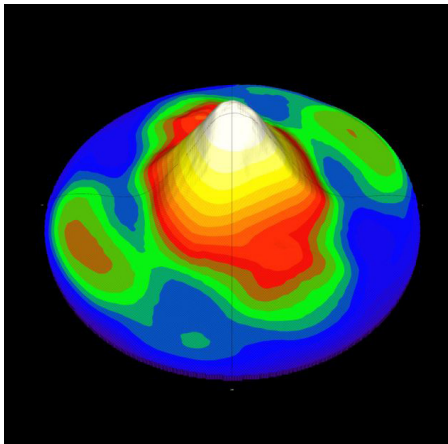

Surface plots for measurements of white, black and contrast

Profiles

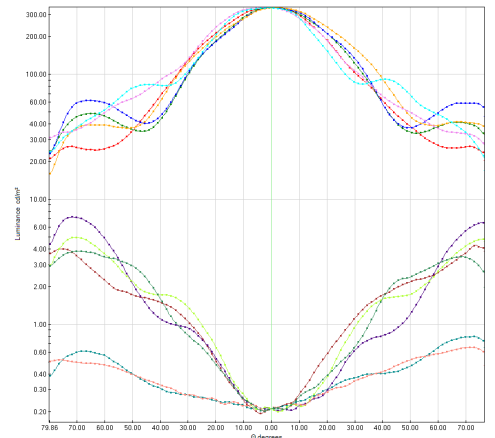
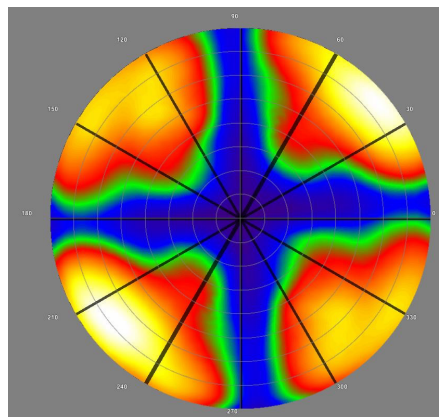
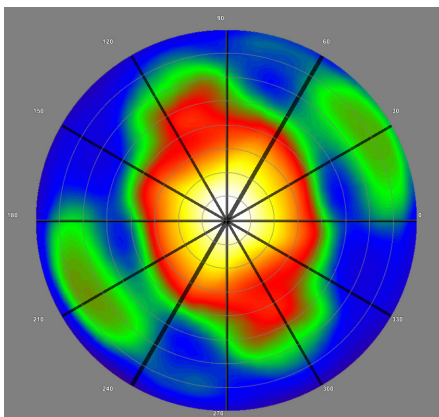

Profiles may be applied and plotted for any measurements in the document. Left and center show profile locations for White and Black measurements and their corresponding luminance profiles on the right.

Gamma

Photometrica supports full gamma analysis versus viewing angle.

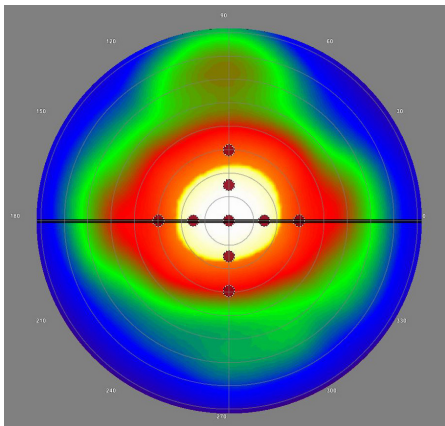

Horizontal profile and 9 user defined AOIs are identified in the two-dimensional measurement of a laptop display.

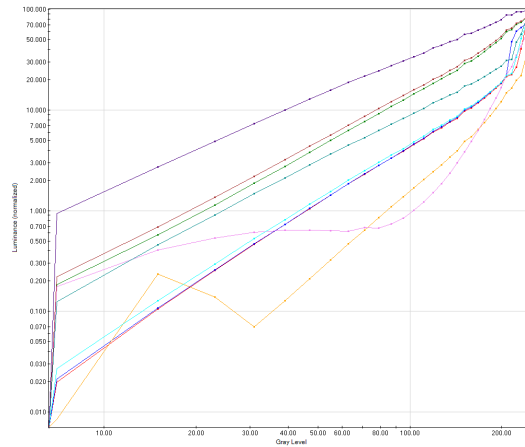

Gamma plot of 9 AOIs over 33 grey levels.

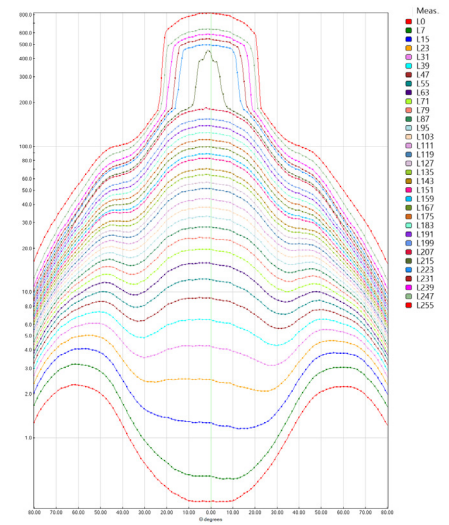

Luminance plot of horizontal profile out to 80 degrees for 33 grey levels.

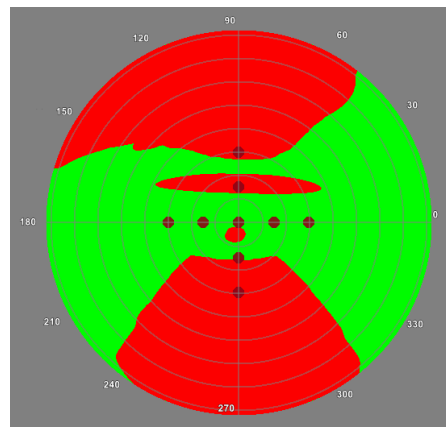

Red shaded areas exhibit gamma inversion (non-monotonic grey scale function).

Customization and Automation

With the software development kit (SDK), scripting within Photometrica is available to simplify the user interface, streamline repetitive tasks, or integrate with external devices such as video pattern generators. For full automation, users may create applications using SOAP (LabVIEW, MATLAB, etc.), or COM (C#, C++, VB) interfaces.

NEED COLOR?

If luminance and color viewing angle measurements are required, then the **Conometer Viewing Angle Lens** with an imaging colorimeter from Westboro Photonics is the solution. The Conometer lens offers Fourier imaging out to $\pm 80^\circ$.



CONOMETER 80

TECHNICAL SPECIFICATIONS

Measurement Area

The working distance can be varied to accommodate the pixel pitch of different displays. For example, a test area of 21 mm in diameter is enough to measure to $\pm 80^\circ$ if the CONOMETER 80 lens almost touches the display glass. Laptop and tablet displays can use the integrated lens hood as a fixed standoff to measure out to $\pm 80^\circ$ over a 54 mm spot diameter. Lower pixel density displays such as monitors and televisions are best measured at longer working distances with correspondingly larger spot sizes.

MEASUREMENT AREA DIAMETER							
Working Distance \ Field of View	20°	40°	50°	60°	70°	80°	
With lens touching LCD glass (mm)	3.2	6.4	8	11	16	21	
Using lens hood (mm)	6.1	11	15	21	30	54	
1 cm separation of lens hood (mm)	17	29	40	58	89	148	

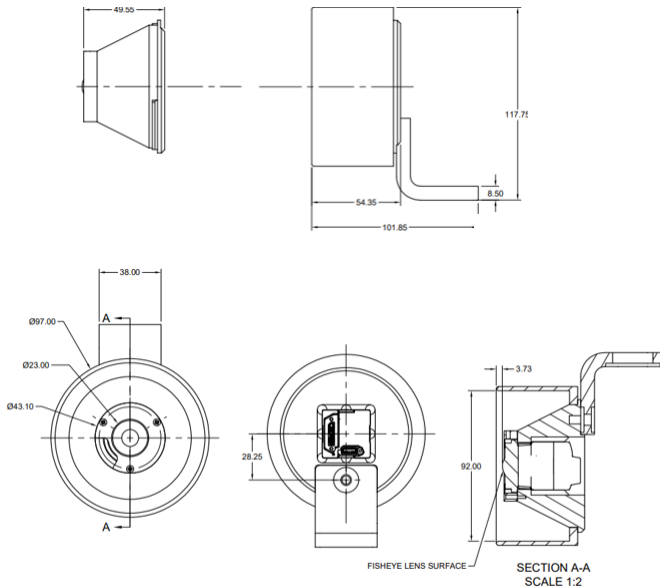

SPECIFICATIONS		CONOMETER 80A	CONOMETER 80B
Lens Hood		Removable	Fixed
Sensor Type		12-bit, Sony IMX, CMOS, global shutter	
Viewing Angle		$\pm 80^\circ$ (160° total)	
Viewing Angle Resolution		0.1°/px	
High Dynamic Range (multi-exposure)		> 1 000 000:1	
Iris settings		F1.8, F16	
Luminance* (Y)	System Accuracy	$\pm 3\%$	
	Short Term Repeatability**	$\pm 0.04\%$	
	Range at F1.8***	0.013 – 7 300 cd/m ²	
	Range at F16***	0.35 – 200 000 cd/m ²	
Measurement Area Diameter	Minimum	21 mm	
	Using lens hood	54 mm	
Spatial Measurement Capabilities		Luminance, Gamma, Contrast, Inversion, User Defined	
Units		cd/m ² , fL, User Defined	
Power		5V via USB 3.1, or over MIPI CSI-2, 3.0 W	
Operating Temperature		23°C \pm 10°C (23°C \pm 2°C to specification accuracy)	
Operating Humidity		10% to 90% (no condensation)	
Mounting Standard		¼" -20 (L-bracket included)	
Electrical Compliance		CE	
Communication Interface		3 m Type A to locking, Type Micro-B USB3. USB3 PCIe card included	
PC Recommendations		2.0 GHz and 4 cores, 8 GB RAM, Windows 10, 64-bit	
Weight		500 g	550 g

Specifications are subject to change. Westboro Photonics continually pursues improvements to the instruments. Specification adjustments, errata or omissions do not constitute grounds for compensation.

* Based on illuminant A source and 4° area (1256 pixels), on-axis, after a 20-minute warmup

** Standard deviation divided by the mean, at 16 ms exposure and > 80% saturation

*** At 0.52 ms and 8.2 s exposures and at signal levels between 2.5% and 95% of saturation